



**OWNER'S MANUAL
MANUEL DU CONDUCTEUR
FAHRER-HANDBUCH**



CB1300

Honda CB1300

OWNER'S MANUAL

MANUEL DU CONDUCTEUR

FAHRER-HANDBUCH

IMPORTANT INFORMATION

- **OPERATOR AND PASSENGER**

This motorcycle is designed to carry the operator and one passenger. Never exceed the maximum weight capacity as shown on the accessories and loading label.

- **ON-ROAD USE**

This motorcycle is designed to be used only on the road.

- **READ THIS OWNER'S MANUAL CAREFULLY**

Pay special attention to the safety messages that appear throughout the manual. These messages are fully explained in the "A Few Words About Safety" section which appears before the Contents page.

This manual should be considered a permanent part of the motorcycle and should remain with the motorcycle when resold.

Honda CB1300 OWNER'S MANUAL

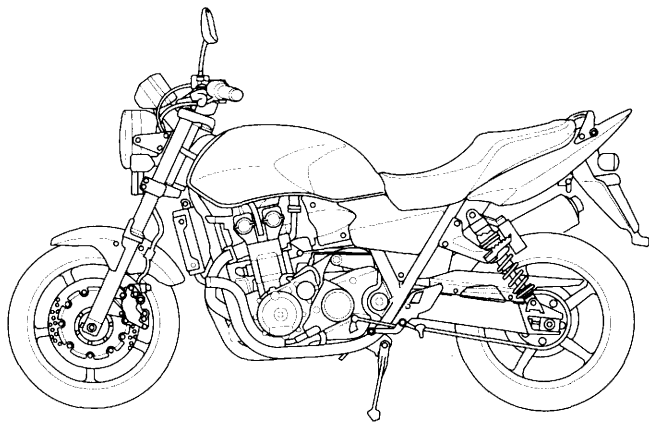

All information in this publication is based on the latest production information available at the time of approval for printing. Honda Motor Co.,Ltd. reserves the right to make changes at any time without notice and without incurring any obligation.

No part of this publication may be reproduced without written permission.

WELCOME

The motorcycle presents you a challenge to master the machine, a challenge to adventure. You ride through the wind, linked to the road by a vehicle that responds to your commands as no other does. Unlike an automobile, there is no metal cage around you. Like an airplane, a pre-ride inspection and regular maintenance are essential to your safety. Your reward is freedom.

To meet the challenges safely, and to enjoy the adventure fully, you should become thoroughly familiar with this owner's manual **BEFORE YOU RIDE THE MOTORCYCLE**.

As you read this manual, you will find information that is preceded by a **NOTICE** symbol. This information is intended to help you avoid damage to your motorcycle, other property, or the environment.

When service is required, remember that your Honda dealer knows your motorcycle best. If you have the required mechanical "know-how" and tools, your dealer can supply you with an official Honda Service Manual to help you perform many maintenance and repair tasks.

Pleasant riding, and thank you for choosing a Honda !

- Following codes in this manual indicate each country.

E	UK	F	France
ED	European direct sales	U	Australia
	Belgium		
	Holland		
	Spain		
	Italy		
	Portugal		
	Germany		
	Switzerland		
	Hungary		

- The specifications may vary with each locale.

A FEW WORDS ABOUT SAFETY

Your safety, and the safety of others, is very important. And operating this motorcycle safely is an important responsibility.

To help you make informed decisions about safety, we have provided operating procedures and other information on labels and in this manual. This information alerts you to potential hazards that could hurt you or others.

Of course, it is not practical or possible to warn you about all hazards associated with operating or maintaining a motorcycle. You must use your own good judgment.

You will find important safety information in a variety of forms, including:

- **Safety Labels** — on the motorcycle.
- **Safety Messages** — preceded by a safety alert symbol  and one of three signal words: **DANGER**, **WARNING**, or **CAUTION**.

These signal words mean:

▲ DANGER

You **WILL** be **KILLED** or **SERIOUSLY HURT** if you don't follow instructions.

▲ WARNING

You **CAN** be **KILLED** or **SERIOUSLY HURT** if you don't follow instructions.

▲ CAUTION

You **CAN** be **HURT** if you don't follow instructions.

- **Safety Headings** — such as Important Safety Reminders or Important Safety Precautions.
- **Safety Section** — such as Motorcycle Safety.
- **Instructions** — how to use this motorcycle correctly and safely.

This entire manual is filled with important safety information — please read it carefully.

OPERATION

page

1	MOTORCYCLE SAFETY
1	Important Safety Information
2	Protective Apparel
4	Load Limits and Guidelines
8	PARTS LOCATION
11	Instruments and Indicators
42	MAJOR COMPONENTS (Information you need to operate this motorcycle)
42	Suspension
46	Handlebar Position
47	Brakes
50	Clutch
52	Coolant
54	Fuel
57	Engine Oil
58	Tubeless Tyres

page

64	ESSENTIAL INDIVIDUAL COMPONENTS
64	Ignition Switch
65	Keys
67	Immobilizer System (HISS)
70	Right Handlebar Controls
71	Left Handlebar Controls

page

72	FEATURES (Not required for operation)
72	Steering Lock
73	Seat
74	Helmet Holder
75	Document Bag
76	Center Compartment
77	Storage Compartment for U-Shaped Anti-theft Lock
78	Side Cover
79	Fuel Tank Maintenance Position
81	Headlight Aim Vertical Adjustment

page

82	OPERATION
82	Pre-ride Inspection
84	Starting the Engine
89	Running-in
90	Riding
92	Braking
93	Parking
94	Anti-theft Tips

MAINTENANCE

page		page	
95	MAINTENANCE	138	Stoplight Switch Adjustment
95	The Importance of Maintenance	139	Bulb Replacement
96	Maintenance Safety		
97	Safety Precautions	145	CLEANING
98	Maintenance Schedule		
101	Tool Kit	149	STORAGE GUIDE
102	Serial Numbers	149	Storage
103	Colour Label	151	Removal from Storage
104	Engine Oil		
108	Crankcase Breather	152	SPECIFICATIONS
110	Spark Plugs		
113	Throttle Operation	156	CATALYTIC CONVERTER
114	Idle Speed		
115	Air Cleaner	157	NOISE CONTROL SYSTEM (AUSTRALIA ONLY)
116	Coolant		
117	Drive Chain		
123	Drive Chain Slider		
124	Front and Rear Suspension Inspection		
125	Side Stand		
126	Wheel Removal		
131	Brake Pad Wear		
133	Battery		
135	Fuse Replacement		

MOTORCYCLE SAFETY

IMPORTANT SAFETY INFORMATION

Your motorcycle can provide many years of service and pleasure – if you take responsibility for your own safety and understand the challenges that you can meet on the road.

There is much that you can do to protect yourself when you ride. You'll find many helpful recommendations throughout this manual. Following are a few that we consider most important.

Always Wear a Helmet

It's a proven fact: helmets significantly reduce the number and severity of head injuries. So always wear an approved motorcycle helmet and make sure your passenger does the same. We also recommend that you wear eye protection, sturdy boots, gloves, and other protective gear (page 2).

Make Yourself Easy to See

Some drivers do not see motorcycles because they are not looking for them. To make yourself more visible, wear bright reflective clothing, position yourself so other drivers can see you, signal before turning or changing lanes, and use your horn when it will help others notice you.

Ride Within Your Limits

Pushing the limits is another major cause of motorcycle accidents. Never ride beyond your personal abilities or faster than conditions warrant. Remember that alcohol, drugs, fatigue and inattention can significantly reduce your ability to make good judgements and ride safely.

Don't Drink and Ride

Alcohol and riding don't mix. Even one drink can reduce your ability to respond to changing conditions, and your reaction time gets worse with every additional drink. So don't drink and ride, and don't let your friends drink and ride either.

Keep Your Bike in Safe Condition

For safe riding, it's important to inspect your motorcycle before every ride and perform all recommended maintenance. Never exceed load limits, and only use accessories that have been approved by Honda for this motorcycle. See page 4 for more details.

PROTECTIVE APPAREL

For your safety, we strongly recommend that you always wear an approved motorcycle helmet, eye protection, boots, gloves, long pants, and a long-sleeved shirt or jacket whenever you ride. Although complete protection is not possible, wearing proper gear can reduce the chance of injury when you ride.

Following are suggestions to help you choose proper gear.

WARNING

Not wearing a helmet increases the chance of serious injury or death in a crash.

Be sure you and your passenger always wear a helmet, eye protection and other protective apparel when you ride.

Helmets and Eye Protection

Your helmet is your most important piece of riding gear because it offers the best protection against head injuries. A helmet should fit your head comfortably and securely. A bright-coloured helmet can make you more noticeable in traffic, as can reflective strips.

An open-face helmet offers some protection, but a full-face helmet offers more. Always wear a face shield or goggles to protect your eyes and help your vision.

Additional Riding Gear

In addition to a helmet and eye protection, we also recommend:

- Sturdy boots with non-slip soles to help protect your feet and ankles.
- Leather gloves to keep your hands warm and help prevent blisters, cuts, burns and bruises.
- A motorcycle riding suit or jacket for comfort as well as protection. Bright-coloured and reflective clothing can help make you more noticeable in traffic. Be sure to avoid loose clothes that could get caught on any part of your motorcycle.

LOAD LIMITS AND GUIDELINES

Your motorcycle has been designed to carry you and one passenger. When you carry a passenger, you may feel some difference during acceleration and braking. But so long as you keep your motorcycle well-maintained, with good tyres and brakes, you can safely carry loads within the given limits and guidelines.

However, exceeding the weight limit or carrying an unbalanced load can seriously affect your motorcycle's handling, braking and stability. Non-Honda accessories, improper modifications, and poor maintenance can also reduce your safety margin.

The following pages give more specific information on loading, accessories and modifications.

Loading

How much weight you put on your motorcycle, and how you load it, are important to your safety. Anytime you ride with a passenger or cargo you should be aware of the following information.

WARNING

Overloading or improper loading can cause a crash and you can be seriously hurt or killed.

Follow all load limits and other loading guidelines in this manual.

Load Limits

Following are the load limits for your motorcycle:

Maximum weight capacity:

188 kg (414 lbs)

Includes the weight of the rider, passenger, all cargo and all accessories

Maximum cargo weight:

27 kg (60 lbs)

The weight of added accessories will reduce the maximum cargo weight you can carry.

Loading Guidelines

Your motorcycle is primarily intended for transporting you and a passenger. You may wish to secure a jacket or other small items to the seat when you are not riding with a passenger.

If you wish to carry more cargo, check with your Honda dealer for advice, and be sure to read the information regarding accessories on page 6 .

Improperly loading your motorcycle can affect its stability and handling. Even if your motorcycle is properly loaded, you should ride at reduced speeds and never exceed 130 km/h (80 mph) when carrying cargo.

Follow these guidelines whenever you carry a passenger or cargo:

- Check that both tyres are properly inflated.
- If you change your normal load, you may need to adjust the front suspension (page 42) and the rear suspension (page 44).
- To prevent loose items from creating a hazard, make sure that all cargo is securely tied down before you ride away.
- Place cargo weight as close to the center of the motorcycle as possible.
- Balance cargo weight evenly on both sides.

Accessories and Modifications

Modifying your motorcycle or using non-Honda accessories can make your motorcycle unsafe. Before you consider making any modifications or adding an accessory, be sure to read the following information.

WARNING

Improper accessories or modifications can cause a crash in which you can be seriously hurt or killed.

Follow all instructions in this owner's manual regarding accessories and modifications.

Accessories

We strongly recommend that you use only genuine Honda accessories that have been specifically designed and tested for your motorcycle. Because Honda cannot test all other accessories, you must be personally responsible for proper selection, installation and use of non-Honda accessories. Check with your dealer for assistance and always follow these guidelines:

- Make sure the accessory does not reduce ground clearance and lean angle, limit suspension travel or steering travel, alter your riding position or interfere with operating any controls.
- Be sure electrical equipment does not exceed the motorcycle's electrical system capacity (page 155). A blown fuse can cause a loss of lights or engine power.

- Do not pull a trailer or sidecar with your motorcycle. This motorcycle was not designed for these attachments, and their use can seriously impair your motorcycle's handling.

Modifications

We strongly advise you not to remove any original equipment or modify your motorcycle in any way that would change its design or operation. Such changes could seriously impair your motorcycle's handling, stability and braking, making it unsafe to ride.

Removing or modifying your lights, mufflers, emission control system or other equipment can also make your motorcycle illegal.

PARTS LOCATION

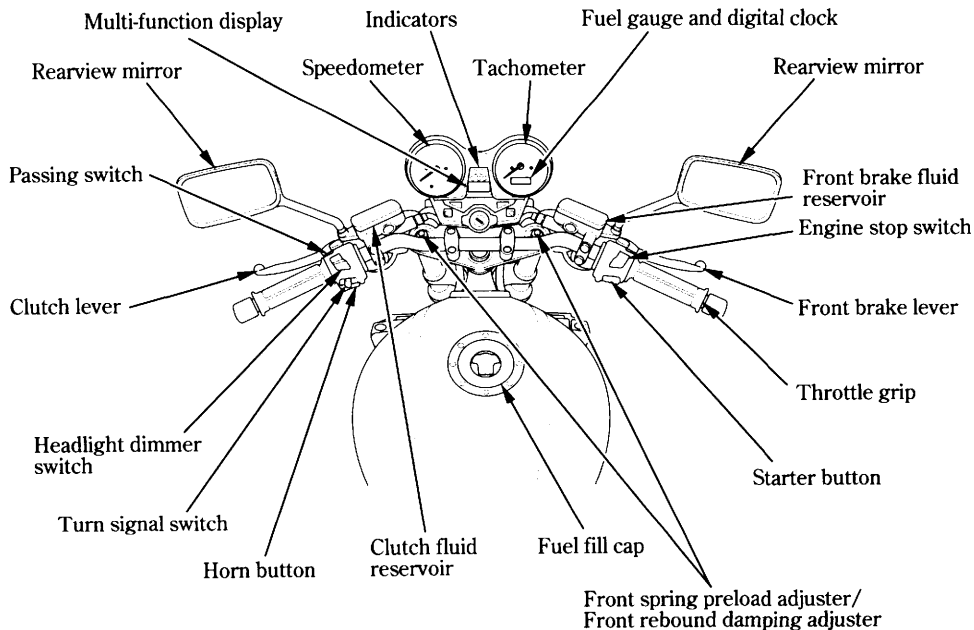

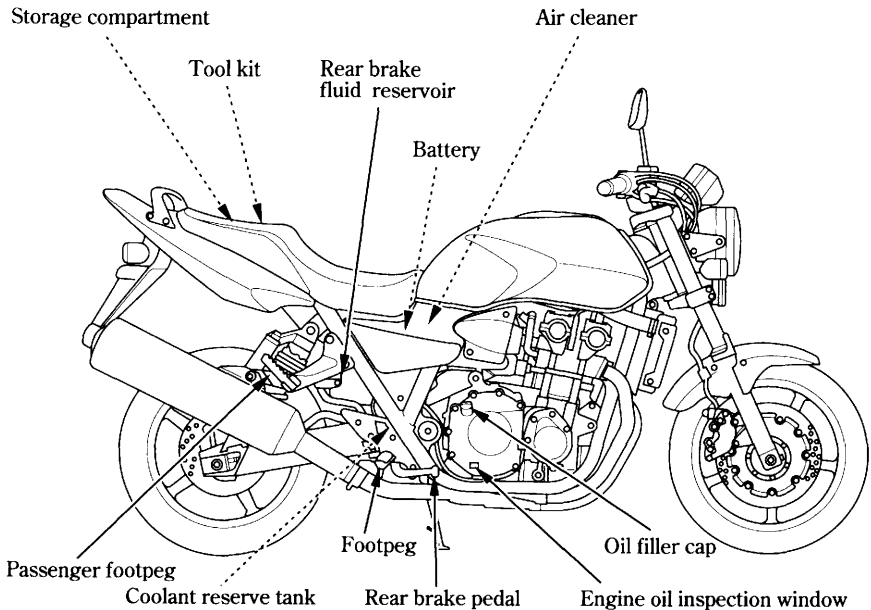

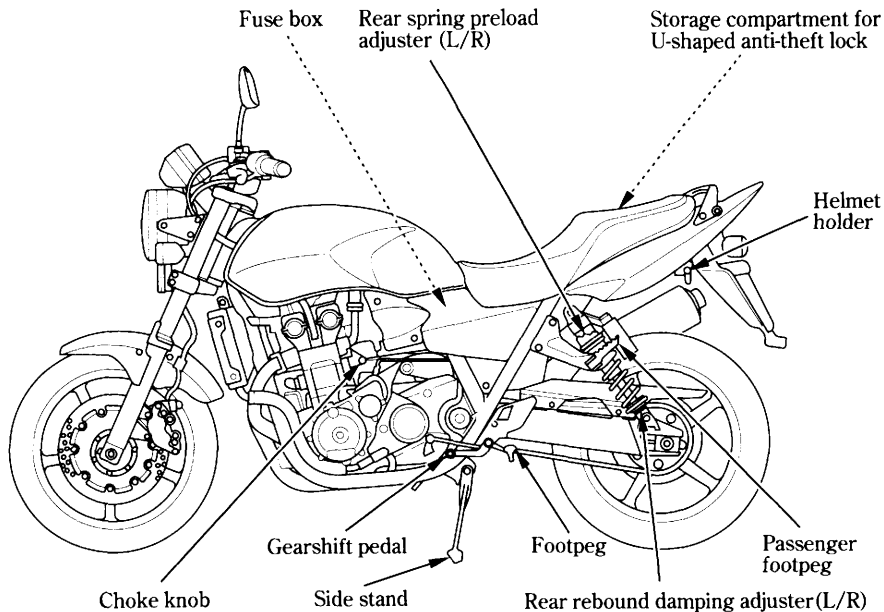

INSTRUMENTS AND INDICATORS

The indicators are contained in the instrument panel. Their functions are described in the tables on the following pages.

- (1) Tachometer
- (2) Tachometer red zone
- (3) Fuel gauge and Digital clock
- (4) Right turn signal indicator
- (5) Right control button
- (6) Left turn signal indicator
- (7) Left control button
- (8) Multi-function display
- (9) Immobilizer system (HISS) indicator
- (10) Speedo meter
- (11) PGM-FI indicator
- (12) Low oil pressure indicator
- (13) Neutral indicator
- (14) High beam indicator
- (15) Coolant temperature indicator

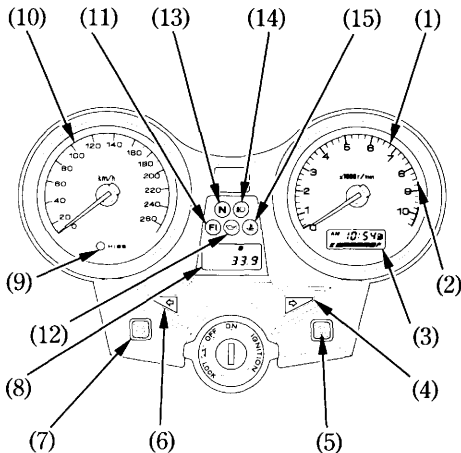

(Ref.No.) Description	Function
(1) Tachometer	Shows engine revolutions per minute.
(2) Tachometer red zone	<p>Never allow the tachometer needle to enter the red zone, even after the engine has been broken in.</p> <p>NOTICE</p> <p>Running the engine beyond recommended maximum engine speed (the beginning of the tachometer red zone) can damage the engine.</p>
(3) Fuel gauge and digital clock	Shows approximate fuel supply available (page 38). Shows hour and minute (page 40).

(Ref.No.) Description	Function
(4) Right turn signal indicator (green)	Flashes when the right turn signal operates.
(5) Right control button	Use this button for the following purposes. <ul style="list-style-type: none">• To select display mode• To start and pause the stopwatch• To set the scheduled date• To set mileage countdown

(Ref.No.) Description	Function
(6) Left turn signal indicator (green)	Flashes when the left turn signal operates.
(7) Left control button	Use this button for the following purposes. <ul style="list-style-type: none"> • To adjust time • To select display mode • To reset tripmeter • To set the scheduled date • To set mileage countdown • To switch blinking of the immobilizer system (HISS) indicator

(Ref.No.) Description	Function
(8) Multi-function display (Display mode 1)	The display includes the following functions; This display shows the initial display (page 20).
Odometer	Shows accumulated mileage (page 22).
Tripmeter 1 and 2	Shows mileage per trip (page 22).
Coolant temperature meter	Shows coolant temperature (page 24).

(Ref.No.) Description	Function
(8) Multi-function display (Display mode 2)	The display includes the following functions; This display shows the initial display (page 20).
DAYS	Shows scheduled date (page 26).
Stopwatch	Shows stopwatch (page 29).
Mileage Countdown	Shows subtraction mileage (page 31).
TODAY	Shows the current days and mileage (page 34).
Air temperature meter	Shows air temperature (page 36).

(Ref.No.) Description	Function
(9) Immobilizer system (HISS) indicator (red)	<p>This indicator lights for a few seconds when the ignition switch is turned ON and the engine stop switch is at \odot (RUN). It will then go off if the properly-coded key has been inserted. If an improperly-coded key has been inserted, the indicator will remain on and the engine will not start (page 67).</p> <p>When the blinking function of this indicator is valid and the ignition switch is OFF, it keeps blinking for 24 hours (page 68).</p>
(10) Speedometer	Shows riding speed.
(11) PGM-FI indicator (red)	<p>Lights when there is any abnormality in the PGM-FI (Programmed Fuel Injection) system. Should also light for a few seconds and then go off when the ignition switch is turned ON and engine stop switch is at \odot (RUN).</p> <p>If it comes on at any other time , reduce speed and take the motorcycle to your Honda dealer as soon as possible.</p>

(Ref.No.) Description	Function
(12) Low oil pressure indicator (red)	<p>Lights when the engine oil pressure is below normal operating range. Should light when ignition switch is ON and engine is not running. Should go out when the engine starts, except for occasional flickering at or near idling speed when engine is warm.</p> <p>NOTICE</p> <p>Running the engine with insufficient oil pressure may cause serious engine damage.</p>
(13) Neutral indicator (green)	Lights when the transmission is in neutral.
(14) High beam indicator (blue)	Lights when the headlight is on high beam.

(Ref.No.) Description	Function
(15) Coolant temperature indicator (red)	<p>Lights when the coolant is over the specified temperature. If the indicator goes on while riding, stop the engine and check the reserve tank coolant level. Read pages 52 – 53 and do not ride the motorcycle until the problem has been corrected.</p> <p>NOTICE</p> <p>Exceeding maximum running temperature may cause serious engine damage.</p>

Initial Display

When the ignition switch is turned ON, the display will temporarily show all the modes and digital segments so you can make sure the liquid crystal display is functioning properly.

The digital clock, tripmeter, DAYS and TODAY will reset if the battery is disconnected.

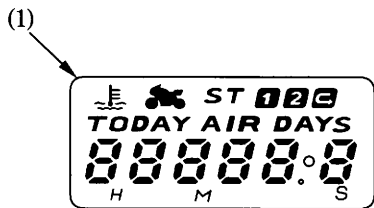

- (1) Multi-function display
- (2) Fuel gauge and digital clock

Multi-function Display

There are two display modes: display mode 1 and display mode 2.

Multi-function display mode 1 includes the following functions:

Odometer

Tripmeter

Coolant temperature meter

Multi-function display mode 2 includes the following functions:

DAYS

Stopwatch

Mileage countdown

TODAY

Air temperature meter

To switch between the display mode 1 and display mode 2, while press and hold the left control button (2), then press and hold the right control button (3) for more than 2 seconds.

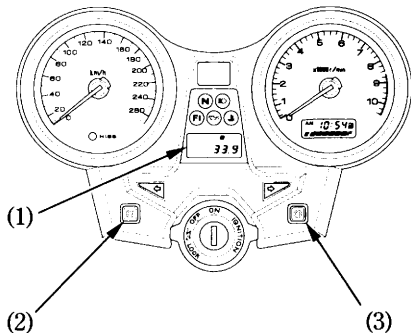

- (1) Multi-function display
- (2) Left control button
- (3) Right control button

Odometer/Tripmeter/Coolant temperature meter (display mode 1)

The Display mode 1 has three functions: odometer, tripmeter and coolant temperature.

Press the left control button (1) to select "ODO" (Odometer), "TRIP 1" (Tripmeter 1), "TRIP 2" (Tripmeter 2) and "TEMP" (Coolant temperature) mode.

ED/F/U model: Odometer and tripmeter read in kilometers.

E model: Odometer and tripmeter read in miles.

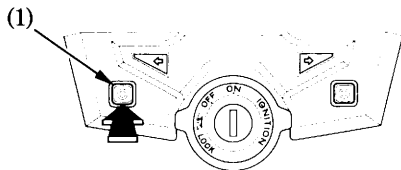

(1) Left control button

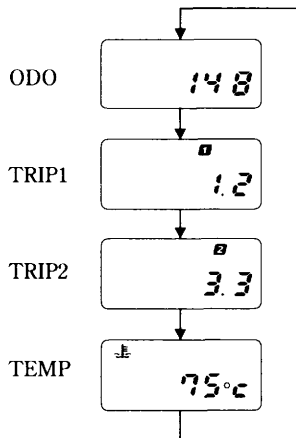

To reset the tripmeter, press and hold the left control button for more than 2 seconds when the display is in the "TRIP" mode.

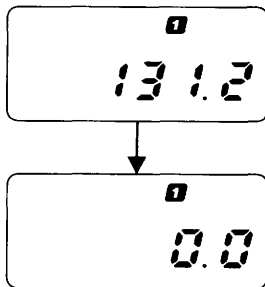

Coolant Temperature Meter

The coolant temperature meter (1) shows coolant temperature digitally.

Temperature Display

Below 35°C	"— —" is displayed.
Between 35°C and 132°C	Actual coolant temperature is indicated.
Above 132°C	The display will remain "132°C".

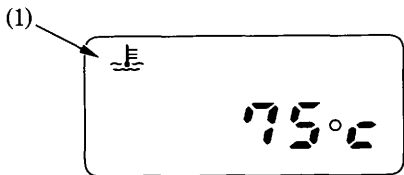

(1) Coolant temperature meter

Overheating Message

When the coolant temperature reaches 122°C, the display begins to flash and coolant temperature indicator (2) goes on. If this occurs, stop the engine and check the reserve tank coolant level. Read pages 52 — 53 and do not ride the motorcycle until the problem has been corrected.

NOTICE

Exceeding maximum running temperature may cause serious engine damage.

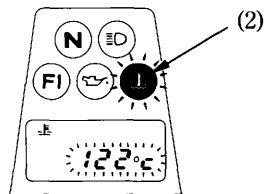

(2) Coolant temperature indicator

DAYS/Stopwatch/Mileage Countdown/ TODAY/Air Temperature Meter (display mode 2)

The display mode 2 has five functions:
DAYS, Stopwatch, Mileage countdown,
TODAY and Air temperature meter.

Push the left control button (1) to select
“DAYS”, “Stopwatch”, “Mileage countdown”,
“TODAY” and “Air temperature meter”.

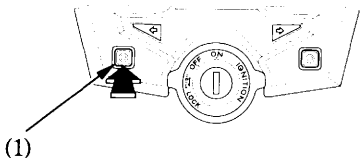

(1) Left control button

DAYS

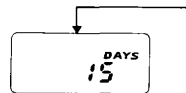

Stopwatch



Mileage
countdown

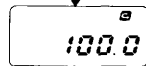

TODAY

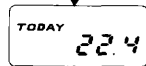

Air
Temperature

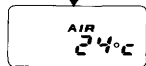

DAYS

DAYS allows you to countdown to a scheduled date in the future.

There are three display mode,

Until the scheduled date:

- The days until the scheduled date is displayed.

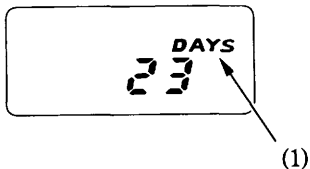

(1) DAYS display

(2) Icon mark

Scheduled date or passed the scheduled date:

- "0" is displayed and Icon mark (2) will light.

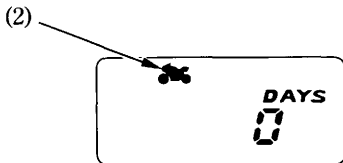

No setting:

- " - - - - " is displayed.

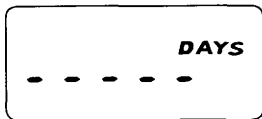

To set scheduled date:

1. Turn the ignition switch ON.
2. Select the DAYS mode.
3. Press the left control button (1) for more than 2 seconds. The display will be set in the adjustment mode with the year display flashing.

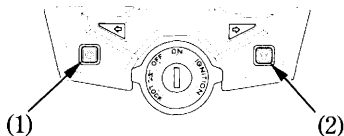
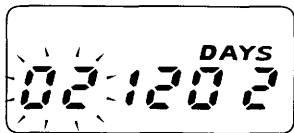

- (1) Left control button
(2) Right control button

4. To set the year, press the right control button (2) until the desired year appears.
 - Quick setting – press and hold the right control button until the desired year appears.
 - If setting “-” while adjusting year, scheduled date is not set.
5. Press the left control button when the display reaches the desired year. The month display will be flashing.

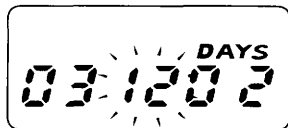

6. Repeat steps 4 and 5 for the month and day.

If the ignition switch is turned off or no operation is performed for 5 seconds during the adjustment mode, the set date will reset.

When the battery terminal is disconnected:

- If the scheduled date has been set, "0" will be flashing and the Icon mark will be lit.
- If the scheduled date is not set, " - - - - " will be displayed.

Stopwatch

The stopwatch will count hours, minutes and seconds.

Stopwatch measurement range:

After measuring 9 hours, 59 minutes, 59.9 seconds, it returns to 0 hours, 0 minutes, 00.0 seconds and will continue counting.

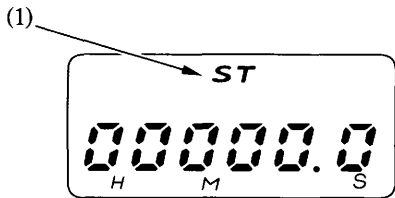

- (1) Stopwatch
- (2) Right control button

How to measure time

1. Select the stopwatch mode.
2. To measure, push the right (2) control button. While measuring, push the right control button to pause and push it again to resume.

START

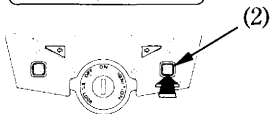

PAUSE

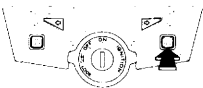

Stopwatch RESET:

Press and hold the left control button (1) for more than 2 seconds when the stopwatch is paused.

PAUSE



RESET

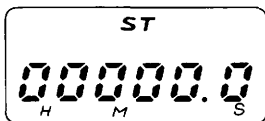

(1)

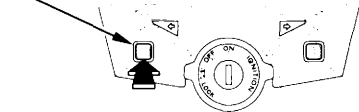

(1) Left control button

Mileage Countdown

In this mode, the mileage will be subtracted from the preset figure. When the mileage exceeds the preset figure, the numeric will flash.

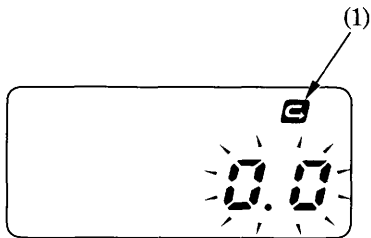

How to set distance:

1. Turn the ignition switch ON.
2. Select the mileage countdown.
3. Press and hold the left control button (2) for more than 2 seconds.
 - Display will change to the set distance mode or reset to the initial setting. See following Example page.

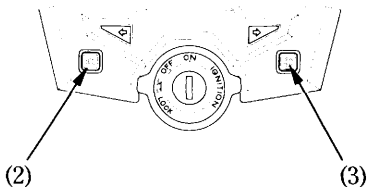

- (1) Mileage countdown display
- (2) Left control button
- (3) Right control button

Example

- If you set the trip mileage, then reset before completing the set distance, the subtraction trip mode will reset to the initial setting.
- If you set the subtraction trip mode and do not travel, you will have to re-enter the trip distance.

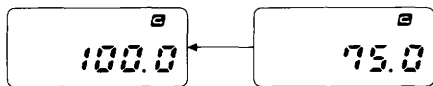

Reset to the initial setting.

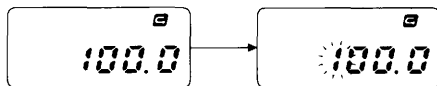

Change to the set distance mode.

4. The preset figure is displayed and the third digit will be flashing.

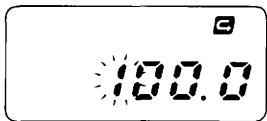

5. To set the third digit, press the right control button (3) until the desired third digit appears.

- Quick setting – press and hold the right control button until the desired third digit appears.

6. Press the left control button when the display reaches the desired figure. The second digit will be flashing.

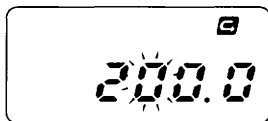

7. Repeat steps 5 and 6 for the second and first digits.

If the ignition switch is turned off or no operation is performed for 5 seconds during the adjustment mode, the set digits will reset.

TODAY

Shows the present date for 5 seconds and then shows today's mileage.

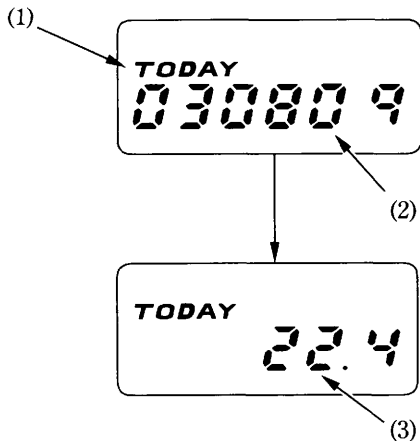

- (1) TODAY display
- (2) Present date
- (3) Today's mileage

How to set date:

1. Turn the ignition switch ON.
2. Select the TODAY mode.
3. During the present date display (for 5 seconds), press and hold the right control button (4) for more than 2 seconds.
The year display will be flashing.

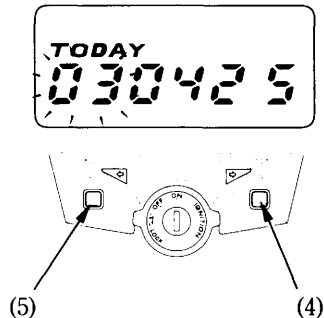

- (4) Right control button
- (5) Left control button

- To set the year, press the right control button (4) until the desired year appears.
 - Quick setting – press and hold the right control button until the desired year appears.
- Press the left control button when the display reaches the desired year. The month display will be flashing.

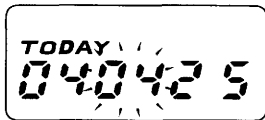

- Repeat steps 5 and 6 for the month and day.

- After finishing the data setting, change over to digital clock setting mode. To set the digital clock. See page 40.

If the ignition switch is turned off or no operation is performed for 5 seconds during the adjustment mode, the set date will reset.

The mileage will reset to "0.0" and the present date will reset to "000101 AM 1:00" if the battery terminal is disconnected.

Air Temperature Meter

Air temperature meter (1) shows air temperature digitally.

To select the Air temperature mode, push the left control button (2).

Temperature Display

Below -10°C	“- -” is displayed.
Between -10°C and 50°C	Actual air temperature is indicated.
Above 50°C	The display will remain “ 50°C ”.

The temperature sensor is located in the meter. Therefore, the temperature reading can be affected by heat reflection from the road surface, engine heat, and the exhaust from the surrounding traffic. This can cause the temperature reading not to be correct when your speed is under 30 km/h (19 mph).

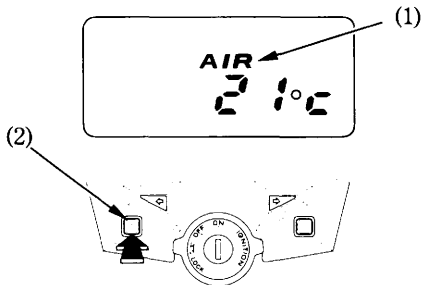

- (1) Air temperature meter
- (2) Left control button

Fuel gauge and digital clock

The fuel gauge and digital clock display (1) includes the fuel gauge liquid crystal display (2) and the digital clock (3).

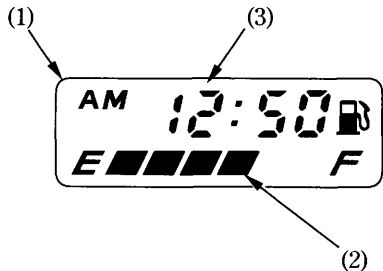

- (1) Fuel gauge and digital clock
- (2) Fuel gauge display
- (3) Digital clock

Fuel Gauge

The fuel gauge liquid crystal display (1) shows the approximate fuel supply available in a graduated display. When the segment F (2) goes on, the fuel tank capacity including reserve is:

21.0 l (5.55 US gal , 4.62 Imp gal)

When the display flashes as shown in the illustration, fuel will be low and you should refill the tank as soon as possible.

The amount of fuel left in the tank with the vehicle set upright is approximately:

4.0 l (1.06 US gal , 0.88 Imp gal)

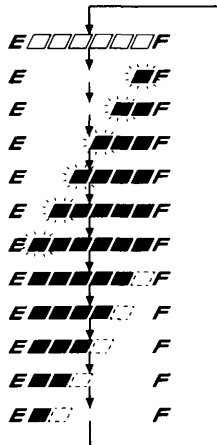
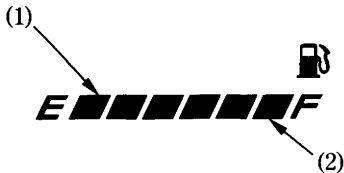

- (1) Fuel gauge display
- (2) Segment F

Fuel Gauge Failure Indication:

If the fuel system has an error, the fuel gauge indicators will be displayed as shown in the illustration.

In this occur, see your Honda dealer as soon as possible.

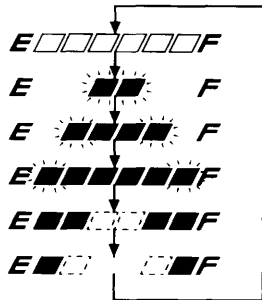

Digital clock

The digital clock will show hours and minutes up to 12:59 with “AM” and “PM”.

To adjust the time, proceed as follows:

1. Turn the ignition switch ON.
2. Press and hold the right control button (1) for more than 2 seconds. The clock will be set in the adjust mode with the display flashing.
 - When TODAY present date or Stopwatch is displayed, adjust mode can not be selected.

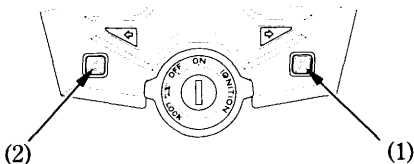

- (1) Right control button
(2) Left control button

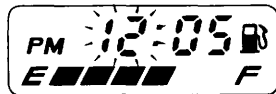

3. To set the hour, press the right control button until the desired hour and AM/PM are displayed.
 - Quick setting – press and hold the right control button until the desired hour appears.
4. Press the left control button (2) when the display reaches the desired hour appears.
The minute display will be flashing.



5. To set the minute, press the right control button until the desired minute appears.
 - Quick setting – press and hold the right control button until the desired minute appears.
6. Press the left control button when the display reaches the desired minute appears.

The display will stop flashing.

If the ignition switch is turned off or no operation is performed for 5 seconds during the time adjustment mode, the clock will reset.

The clock will be reset AM 1:00 if the battery is disconnected.

MAJOR COMPONENTS

(Information you need to operate this motorcycle)

SUSPENSION

Front Suspension

Spring Preload:

Adjust the spring preload by turning the preload adjuster (1) with the 14 × 17 mm wrench provided in the tool kit.

Make sure that both fork legs are adjusted to the same position.

To reduce (SOFT) :

Turn the adjuster counterclockwise toward SOFT for a light load and smooth road condition.

To increase (HARD) :

Turn the adjuster clockwise toward HARD for a firmer ride and rough road condition.

Standard Position:

To return to the standard position, turn the adjusters until the fourth groove from the top aligns with the top surface of the fork caps.

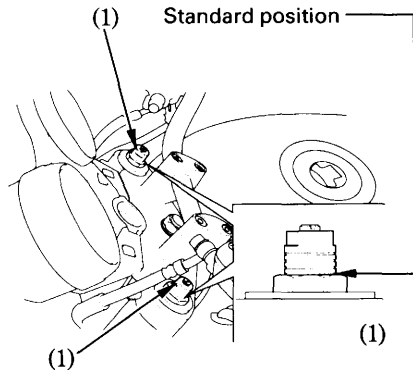

(1) Preload adjuster

Rebound Damping:

To reduce (SOFT) :

Turn the adjuster counterclockwise toward SOFT for a light load and smooth road condition.

To increase (HARD) :

Turn the adjuster clockwise toward HARD for a firmer ride and rough road condition.

To adjust the adjuster to the standard position, proceed as follows :

1. Turn the damping adjuster (1) clockwise until it will no longer turn (lightly seats). This is the full hard setting.
2. The adjuster is set in the standard position when the adjuster is turned counterclockwise 1.5 turns.
3. Make sure that both fork legs are adjusted to the same position.

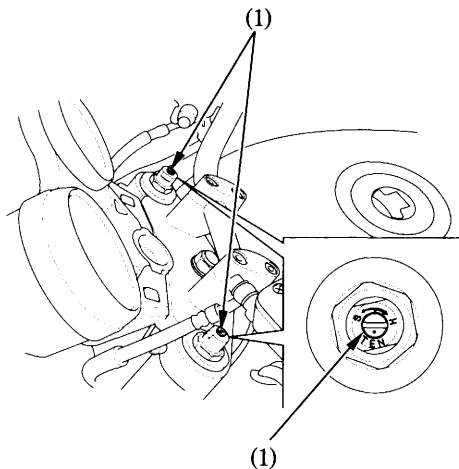

(1) Damping adjuster

Rear Suspension

Rebound Damping:

To reduce (SOFT) :

Turn the adjuster clockwise toward SOFT for a light load and smooth road condition.

To increase (HARD) :

Turn the adjuster counterclockwise toward HARD for a firmer ride and rough road condition.

To adjust the adjuster to the standard position, proceed as follows :

1. Turn the damping adjuster (1) counterclockwise until it will no longer turn. This is the full hard setting.
2. The adjuster is set in the standard position when the adjuster is turned clockwise approximately 10clicks.

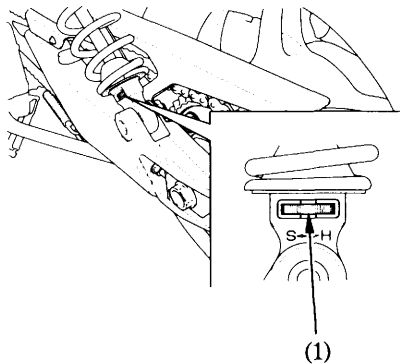

(1) Damping adjuster

Spring Preload:

The spring preload adjuster (1) has 5 spring preload positions for different load or riding conditions.

Use the pin spanner (2) and extension bar (3) to adjust the rear shock.

Position 1 is for a light load and smooth road conditions. Position 2 is the standard position. Positions 3 to 5 increase spring preload for a stiffer rear suspension and can be used when the motorcycle is more heavily loaded.

The rear shock absorber assembly includes a damper unit that contains high pressure nitrogen gas. Do not attempt to disassemble or service the damper; it cannot be rebuilt and must be replaced when worn out. Disposal should only be done by your Honda dealer. The instructions found in this owner's manual are limited to adjustment of the shock assembly only.

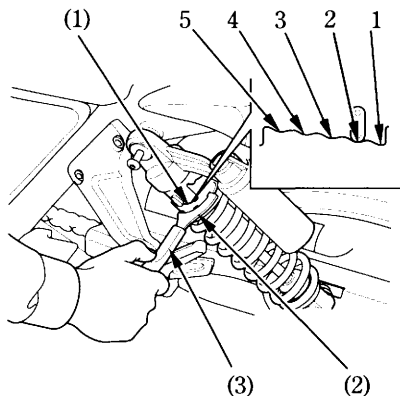

- (1) Spring adjuster
- (2) Pin spanner

- (3) Extension bar

HANDLEBAR POSITION

The handlebar position can be adjusted according to rider preference.

It should be serviced by your Honda dealer.